

Positive Displacement Pumps and Oil-Free Gas Compressors

For Liquefied Gas Applications





Blackmer Liquefied Gas Pumps & Compressors

Durability / High Efficiency / Quiet Operation / Easy Maintenance

Guide to Blackmer Liquefied Gas Equipment

Product	Description / Application	Page
LGF1 LGF1P LGB1 LGB1P	Motor speed pumps for cylinder filling, low volume motor fueling and small vaporizers. Capacities to 15 U.S. gpm (57 lpm).	4 - 5
LGR1F1.25 LGL(F)1.25 LGL1.5	Motor speed pumps for multi-station cylinder filling, motor-fueling, low volume transfer and vaporizers. Capacities to 35 U.S. gpm (132 lpm).	6 - 7
LGLD2 LGLD3 LGLD4 LGL158 LGLH2	Foot-mounted pumps for bulk plants, terminals, vaporizers, bobtails and transports. Capacities to 350 U.S. gpm (1,325 lpm).	8 - 9
TLGLF3 TLGLF4	Flange-mounted pumps for bobtails and transports. Capacities to 350 U.S. gpm (1,325 lpm).	10 - 11
LB161 LB361 LB601 LB942	Oil-free gas compressors for liquid transfer and vapor recovery. Capacities to 125 cfm (212 m ³ /h).	12 - 15
BV $\frac{1}{4}$ BV1 BV1 $\frac{1}{2}$ BV2	Bypass valves for in-line system protection. Capacities to 250 U.S. gpm (946 lpm).	16

Blackmer offers a full line of liquefied gas pumps and oil-free gas compressors, designed for maximum performance and reliability. From the smallest cylinder

High Performance Design Features

Replaceable casing liner and end discs

Blackmer LGL models can be economically rebuilt for like-new performance with replaceable end discs and liners, specially designed to suppress cavitation and reduce wear.

Two-piece threaded lock collars

Precisely position the rotor and shaft, allowing the pump to operate under high inlet pressures. In addition, this positive lock thrust control helps prevent premature wear to internal components.

External ball bearings

Low friction grease-lubricated ball bearings are completely isolated from the pumpage by mechanical seals for trouble-free service and long life.

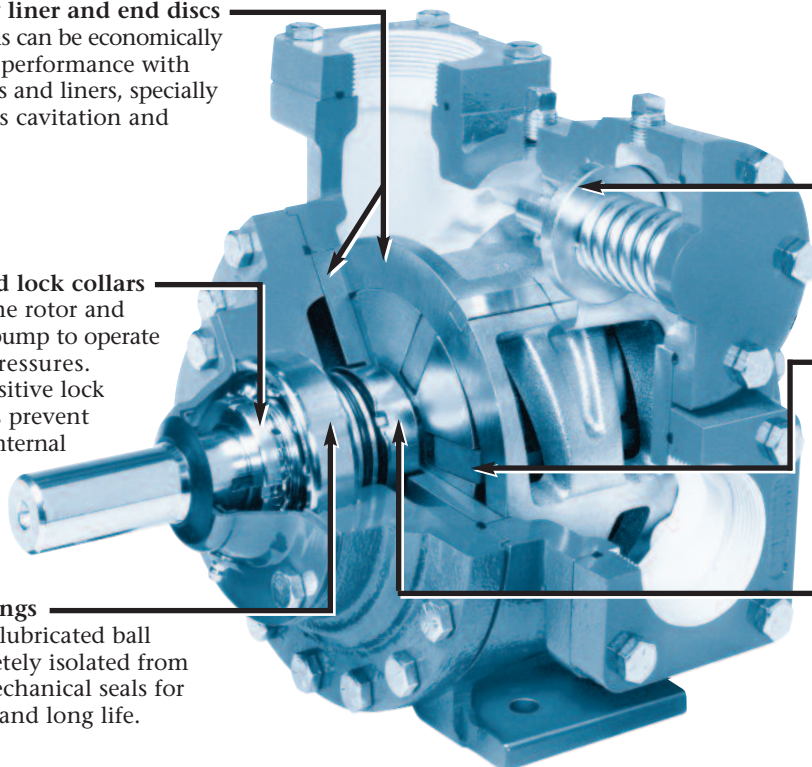

Ductile iron construction

All pressure parts are of ductile iron for greater resistance to both thermal and mechanical shock.

Internal relief valve

Protects the pump from excessive pressure buildup in the event of an obstructed or closed return line.

Nonmetallic Duravanes

Designed to resist wear under non-lubricating conditions. These chemically inert vanes are formulated of a tough resin material for long life and quiet operation.

Blackmer mechanical seals

Specially developed for non-lubricating liquids, Blackmer's exclusive component type design is field proven to provide long life and reliable service on a wide range of liquefied gas applications.

filling operation to the largest, most sophisticated bulk plant/rail car unloading system, you will find Blackmer pumps and compressors operating throughout the world.

Sliding vane design is ideal for butane, propane, anhydrous ammonia, propellants, refrigerants and similar liquefied gases

Blackmer liquefied gas pumps are widely used for cylinder filling, motor fueling, bulk transfer, vaporizers, and on bobtails and transports.

Utilizing Blackmer's unique sliding vane design, these positive displacement pumps offer the best combined characteristics of sustained high-level performance, energy efficiency, trouble-free operation, and low maintenance cost.

Pump models are available in 1 to 4-inch port sizes. All models have ductile iron construction for thermal shock resistance, low friction ball bearings for high efficiency and quiet operation, and threaded lock collars that prevent end thrust wear.

Cavitation Suppression Liners

1.25 through 4-inch models now have special liners that "cushion" the effects of collapsing vapor bubbles within the pump, sharply reducing the noise, vibration, and wear normally caused by entrained vapors.

See page 6 for additional details.

FIGURE 1. How Blackmer's sliding vane action works

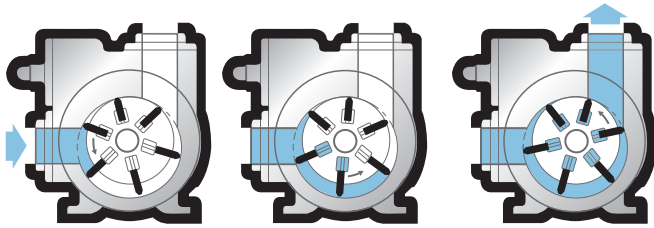

How Blackmer sliding vane pumps achieve high efficiency

As shown in Figure 1, Blackmer pumps use a rotor with sliding vanes that draw the liquid in behind each vane, through the inlet port and into the pumping chamber. As the rotor turns, the liquid is transferred between the vanes to the outlet where it is discharged as the pumping chamber is squeezed down. Each vane provides a positive mechanical push to the liquid before it.

Vane contact with the chamber wall is maintained by three forces: (1) centrifugal force from the rotor's rotation, (2) push rods moving between opposing pairs of vanes, and (3) liquid pressure entering through the vane grooves and acting on the rear of the vanes. Each revolution of a Blackmer pump displaces a constant volume of fluid. Variance in pressure has minimal effect. Energy-wasting turbulence and slippage are minimized and high volumetric efficiency is maintained.

Efficiency means energy savings

The high efficiency of Blackmer pumps means they require less horsepower than other positive displacement pumps. So you spend less on motors initially and less on electricity to operate the pumps after they are installed.

High capacity at lower speeds means reduced wear

The volumetric efficiency of Blackmer pumps saves more than energy. Their inherently low slippage allows them to operate at substantially lower rpms than other positive displacement pump types, while still delivering equivalent output. These lower operating speeds mean quieter operation, longer service life, and reduced maintenance requirements.

Self-adjusting vanes keep performance high

The performance of gear pumps will constantly diminish as wear increases clearances. To compensate for the reduced performance, you must increase the pump speed (which further accelerates pump wear) or put up with reduced capacity until performance drops to a totally unacceptable level. The vanes on a Blackmer pump automatically slide out of their rotor slots to continuously adjust for wear. No more speeding up to compensate and no more putting up with poor performance. Blackmer pumps maintain near-original efficiency and capacity throughout the life of the vanes.

FIGURE 2. How Blackmer's sliding vanes maintain efficiency

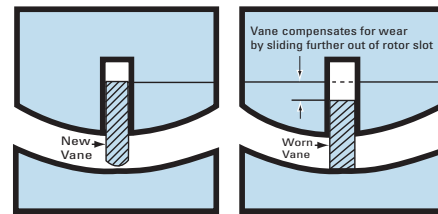

Vane replacement in minutes, easy inspection

Vane replacement is easy. Simply remove the outboard head assembly, slide out the old vanes, insert the new ones, and reinstall the head. In a matter of minutes, your pump is back in operation. Routine inspection is equally easy. In fact, most maintenance can be done without disconnecting the pump from its piping or drive shaft.

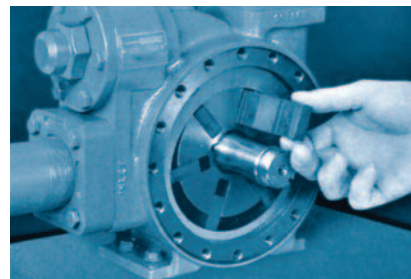

Simple vane replacement requires no special tools.

Replaceable liners economically restore efficiency

Blackmer LGL pumps are equipped with replaceable liners that protect the pump casing and provide the economy of simple replacement, restoring the pump to like-new efficiency. No special tools are required to remove a worn liner and install a new one, and the simple operation can be completed in a few minutes without taking the pump off line.

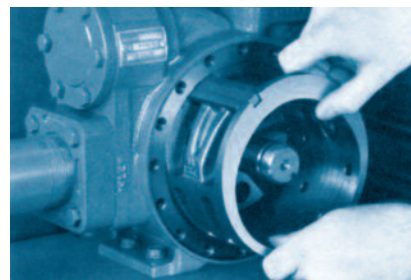

Easily replaceable liner restores efficiency.

UL and ISO 9001

All pump* and bypass valve models described in this bulletin are listed by Underwriters Laboratories for both LP-gas and anhydrous ammonia service. (*LGL158 and LGLH2 are listed for use on LP-gas service only.)

All products in this bulletin are manufactured to ISO 9001 quality standards.





LGF1 & LGB1 Pumps Motor Speed Pumps for Cylinder Filling

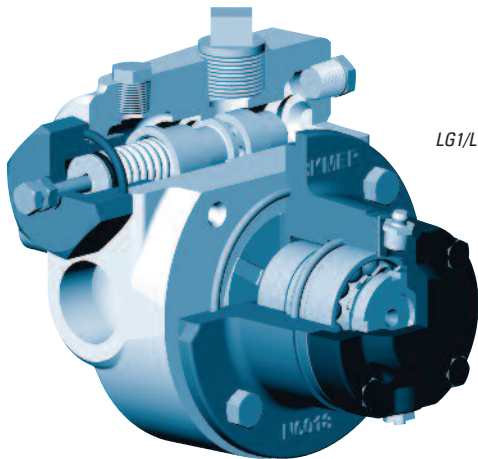

LGF1/LGF1P cutaway

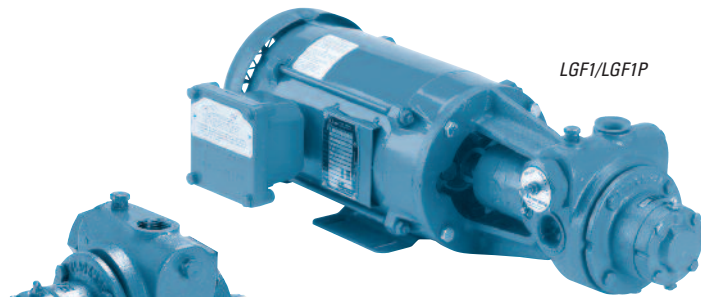

LGF1/LGF1P

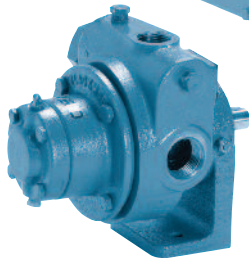

LGB1/LGB1P

These 1-inch motor speed pumps have long been popular for cylinder filling, small volume motor fueling and supplying small vaporizers. They offer the same heavy-duty construction of larger Blackmer models and are available in two mounting styles and capacity ranges. The LGF1 model is fitted with an integral bracket and coupling for direct flange mounting to a NEMA C-face motor. This bracket also allows the pump body to be rotated to simplify hookup to piping systems. The LGB1 model is equipped with a coupling and bracket for mounting to a conventional base. The LGF1 and LGB1 models will handle up to 10 U.S. gpm (38 lpm). The LGF1P and LGB1P models offer 50% greater capacity and will handle up to 15 U.S. gpm (57 lpm).

All models have 1-inch NPT tapped ports and use an exclusive "combination" valve that acts as both a back-to-tank bypass valve and as an internal relief valve. This feature lowers installation costs by eliminating the need for a separate bypass valve. It also assures pressure relief if the back-to-tank bypass line is closed. The valve's unique three-stage operation is shown in Figure 3.

Standard construction materials for these models include Buna-N mechanical seals and Duravanes for handling both LP gas and anhydrous ammonia. Maximum differential pressure is 125 psi (8.62 Bar) for both models.

Assembled Pump Units

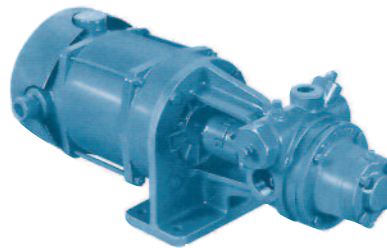

LGF Drive Style Flange Mounting - Direct Motor Drive

LGF1 and LGF1P models are supplied with an integral bracket and flexible

shaft coupling, ready to accept a NEMA C-face motor. All LGF units are available with or without electric motors. Standard motors furnished by Blackmer for these pumps are explosion-proof, single-phase, 115/230 volt, with automatic reset overload protection. An explosion-proof manual switch is also available for mounting at the motor or remote location.

DM Drive Style Bracket Mounting - Direct Motor Drive

LGB1-DM or LGB1P-DM base-mounted units are available, complete with pump, bracket, coupling and coupling guard, mounted on a common base, ready to accept a standard NEMA motor. All DM units are available with or without electric motors.

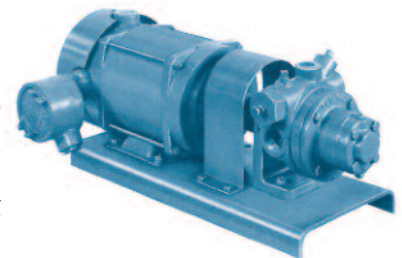
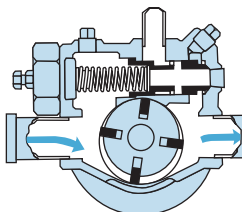
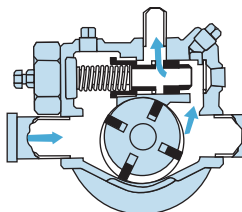

FIGURE 3. Combination relief/bypass valve



Normal Operation

Valve is completely closed during normal operation with discharge line open.



Back-to-Tank Bypassing

Discharge pressure exceeding the valve setting opens valve to second stage, returning all or part of pump flow back to supply tank.

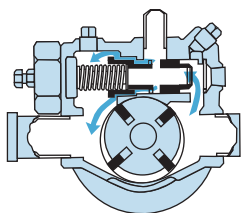

Pressure Relief

If back-to-tank line is closed, valve opens to third stage, passing flow back to inlet side of pump.

Selection Data

When selecting a standard pump or assembled unit from the table below, check the pump's delivery and brake horsepower requirements in the performance curves. These pumps are rated for continuous duty, although such applications may accelerate pump wear rates, particularly if vaporization occurs in the pump

intake line. Pumps used on vaporizers should be mounted with inlet up, and sized for a capacity of at least 150% of the normal peak load to prevent system failure due to sudden pressure drop on start-up. Additional system requirements can be achieved by series of parallel staging.

Assembled Pump Units		Pump and Motor Speed RPM	Approximate Delivery of Propane at Differential Pressures and Pump Speeds Shown ¹				Maximum Differential Pressure		Maximum Working Pressure ³		Normal Time To Fill LP Gas Cylinders in Minutes		Standard Motor ²	Motor Size For Mounting on Standard Base ²	
Model	Factory Relief Valve Setting		50 PSI (3.45 Bar)		100 PSI (6.89 Bar)		PSI	Bar	PSI	Bar	20 LB. (9 KG) Cylinder	100 LB. (45 KG) Cylinder	HP	Minimum Frame Size	Maximum Frame Size
			GPM	LPM	GPM	LPM									
LGF1	105 psi (7.24 Bar)	1,750	8.0	30.3	6.0	22.7	125	8.62	350	24.13	¾	3	1	56C	184C ⁴
LGB1-DM	105 psi (7.24 Bar)	1,750	8.0	30.3	6.0	22.7	125	8.62	350	24.13	¾	3	1	56	184
LGF1P	120 psi (8.27 Bar)	1,750	13.0	49.2	10.0	37.9	125	8.62	350	24.13	½	2	1½	56C	184C ⁴
LGB1P-DM	120 psi (8.27 Bar)	1,750	13.0	49.2	10.0	37.9	125	8.62	350	24.13	½	2	1½	56	184

¹ Check the pump's delivery and brake horsepower requirements in the performance curves below. See footnote with the curves which explains the factors that can cause delivery to vary.

² Motors may be specified from Electric Motor Price List No. 10-MTRG-01 (explosion-proof manual start switch for 1 & 1-1/2 horsepower single-phase motors also available).

³ Maximum rated working pressure is 350 psi (24.13 Bar) for LPG and NH₃ (limited by U.L. and N.F.P.A. 58).

⁴ Pump flange accepts NEMA C-face motors with 5-7/8" bolt circle diameter. Pump flange will not accept 182TC or 184TC frames.

Performance Curves

These curves are based on approximate delivery rates when handling propane or anhydrous ammonia at 80°F (26.7°C). Line restrictions such as excess flow valves, elbows, etc. will adversely affect deliveries. For propane at 32°F (0°C), actual delivery will be further reduced to about 80% of nominal. Delivery of butane at 80°F (26.7°C) will be 60% to 70% of these values, and may run as low as 35% to 45% at 32°F (0°C). This loss of delivery is not a pump characteristic but is caused by natural thermodynamic phenomena of liquefied gases.

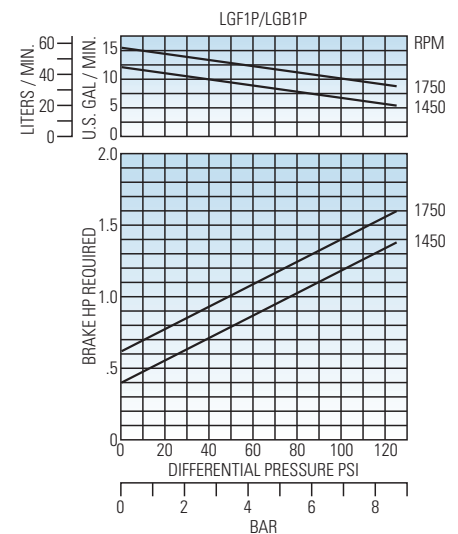
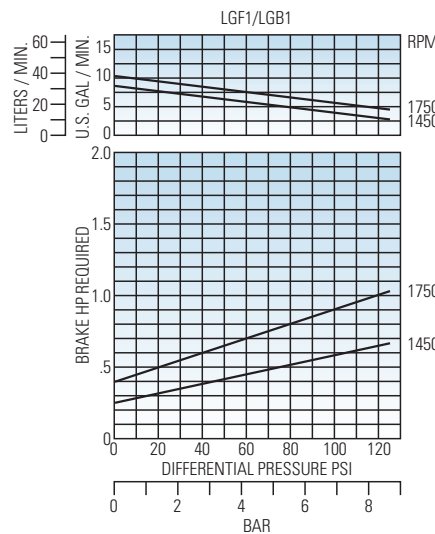



LGL Series Pumps

With Cavitation Suppression Liners

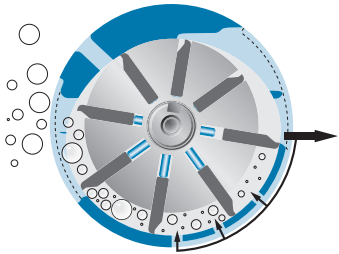

1.25-inch through 4-inch LGL pumps feature noise suppression liners. This patented technology reduces noise at its source by reducing the amount of cavitation in the pump. Reducing the cavitation level also reduces vibration and wear.

The sudden collapse of vapor bubbles inside the pump is known as cavitation. By allowing a controlled amount of fluid at discharge pressure to bleed back toward the suction of the pump, the vapor

bubbles are collapsed over a longer period time. The net result is less noise, less vibration and less wear.

As shown in the chart, the reduction in noise level can be quite dramatic. Similar noise reductions have been measured in all the LGL pump sizes.

Patent number: 6,030,191

Flow and Noise vs. Inlet Vacuum
TLGLF3, 125 psi, 640 rpm

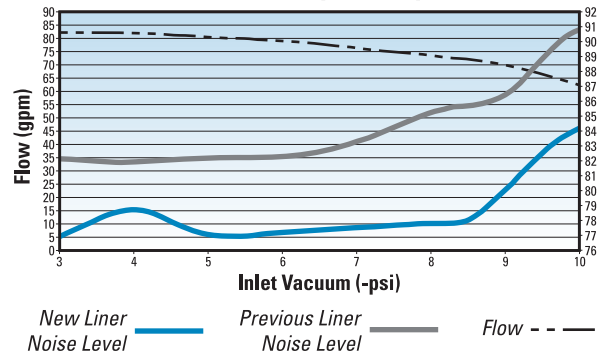

LGR1.25, LGL1.25 & LGL1.5 Pumps

Motor Speed Pumps for Motor Fueling and Multi-Cylinder Filling

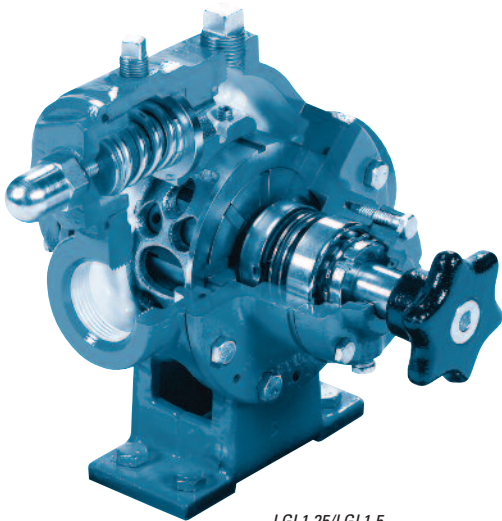

LGL1.25/LGL1.5

These durable motor speed pumps offer capacities from 9 to 35 U.S. gpm (34-132 lpm), and are ideal for motor fueling, multiple-station cylinder filling and a variety of small transfer jobs. The LGL models are designed for foot mounting to a common base-plate. The LGLF models are fitted with an integral bracket and coupling for direct flange mounting to a NEMA C-face motor. This bracket also allows the pump body to be rotated to simplify hookup to piping systems.

Available with 1.25 or 1.5-inch NPT tapped ports, all models are equipped with an internal relief valve, and a replaceable casing liner and end discs for easy rebuilding of the pumping chamber if ever necessary. The LGR1.25-inch model features a special liner, which offers lower flow rates than the LGL 1.25-inch pump. In addition, these pumps feature cavitation suppression liners to reduce noise, vibration and wear.

Standard construction materials for these models include Buna-N mechanical seals and Duravanes for handling both LP gas and anhydrous ammonia. Maximum differential pressure is 150 psi (10.34 Bar) for all models.

Assembled Pump Units

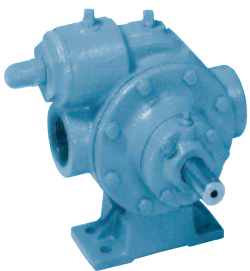

LGL1.25/LGL1.5

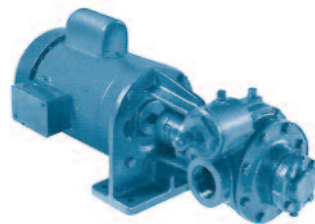

LGF Drive Style

Flange Mounting - Direct Motor Drive

Standard LGR1.25 and LGL1.25 models are supplied with an integral bracket and a flexible shaft coupling, ready to accept a NEMA C-face motor. All LGF units are available with or without electric motors.



DM Drive Style

Foot Mounting - Direct Motor Drive

LGL1.25-DM and LGL1.5-DM base-mounted units are available, complete with pump, coupling and coupling guard, mounted on a common base, ready to accept a standard NEMA motor. All DM units are available with or without electric motors.



LGRLF1.25/LGLF1.25

Performance Curves

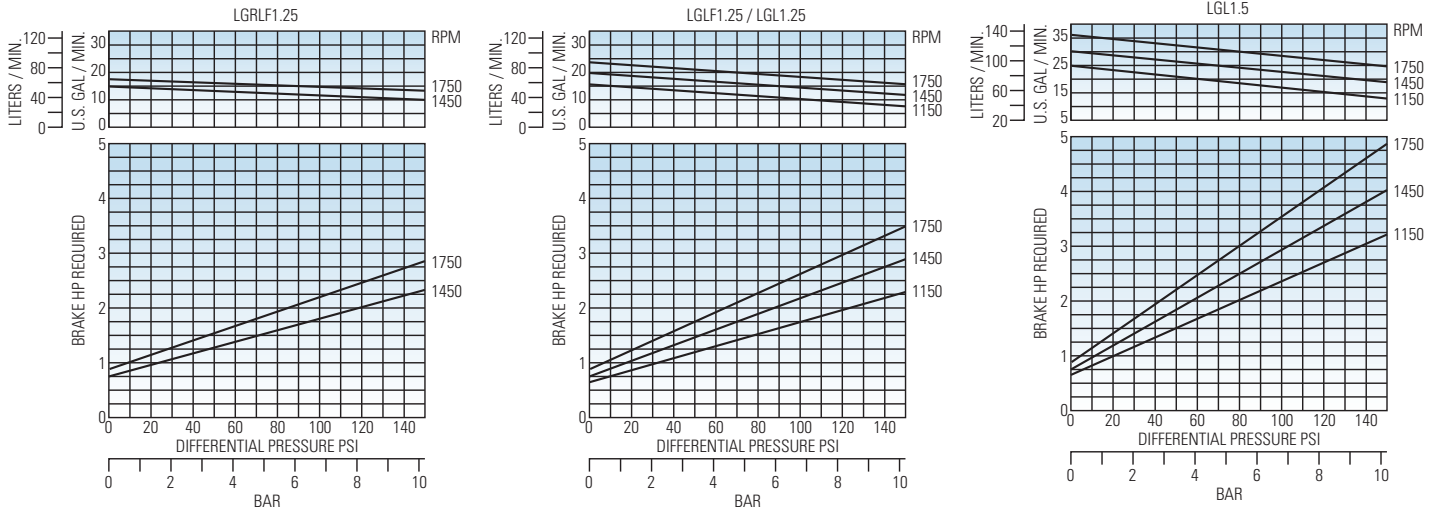

These curves are based on approximate delivery rates when handling propane or anhydrous ammonia at 80°F (26.7°C). Line restrictions such as excess flow valves, elbows, etc. will adversely affect deliveries. For propane at 32°F (0°C), actual delivery will be further reduced to about 80% of nominal. Delivery of butane at 80°F (26.7°C) will be 60% to 70% of these values and may run as low as 35% to 45% at 32°F (0°C). This loss of delivery is not a pump characteristic but is caused by natural thermodynamic phenomena of liquefied gases.

Selection Data

When selecting a standard pump or assembled unit from the table below, check the pump's delivery and brake horsepower requirements in the performance curves. These pumps are rated for continuous duty, although such applications may accelerate pump wear rates, particularly if vaporization occurs in the pump

intake line. Pumps used on vaporizers should be mounted with inlet up, and sized for a capacity of at least 150% of the normal peak load to prevent system failure due to sudden pressure drop on startup. Additional system requirements can be achieved by series or parallel staging.

Assembled Pump Units		Pump and Motor Speed RPM	Approximate Delivery of Propane at Differential Pressures and Pump Speeds Shown ¹				Maximum Differential Pressure		Maximum Working Pressure ²		Motor Size For Mounting on Standard Base ³	
Model	Factory Relief Valve Settings		50 PSI (3.45 Bar)		100 PSI (6.89 Bar)		PSI	Bar	PSI	Bar	Minimum Frame Size	Maximum Frame Size
			GPM	LPM	GPM	LPM						
LGRLF1.25	150 psi (10.34 Bar)	1,750	16.0	60.6	14.0	53.0	150	10.34	350	24.13	56C	184C ⁴
		1,150	13.0	49.2	10.0	37.9	150	10.34	350	24.13	56C	184C ⁴
LGL1.25-DM	150 psi (10.34 Bar)	1,750	21.0	79.5	18.0	68.1	150	10.34	350	24.13	56	215
		1,150	13.0	49.2	10.0	37.9	150	10.34	350	24.13	56	215
LGL1.5-DM	150 psi (10.34 Bar)	1,750	33.0	124.9	29.0	109.8	150	10.34	350	24.13	56	215
		1,150	20.0	75.7	17.0	64.4	150	10.34	350	24.13	56	215

¹ Check the pump's delivery and brake horsepower requirements in the performance curves. See footnote with the curves which explains the factors that can cause delivery to vary.

² Maximum rated working pressure is 350 psi (24.13 Bar) for LPG and NH₃ (limited by U.L. and N.F.P.A. 58).

³ Motors may be specified from Electric Motor Price List No. 10-MTRG-01 (explosion-proof manual start switch for 1 & 1-1/2 horsepower single-phase motors also available).

⁴ Pump flange accepts NEMA C-face motors with 5-7/8" bolt circle diameter. Pump flange will not accept 182TC or 184TC frames.

Note: Refer to back cover for external bypass valve information.



LGLD2, LGLD3 & LGLD4 Pumps

Multi-Purpose Pumps for Bulk Plants, Terminals and Truck Systems

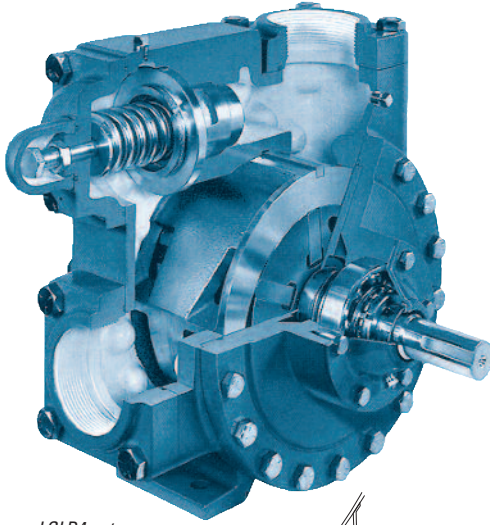

LGLD4 cutaway

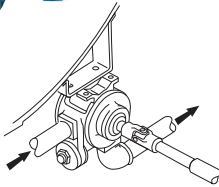

Truck Mounted Drive

Blackmer LGLD2 pumps are often mounted to the chassis of a bobtail, or to a steel pad that is welded to the tank.

The 3- and 4-inch models can be mounted to a transport in a number of different ways, generally near or between the tank landing gear brackets.

Truck mounted pumps are normally driven through a P.T.O. or hydraulic drive system. Refer to Blackmer's Liquefied Gas Handbook-Bulletin 500-001 for various types of bobtail and transport pump systems.

These rugged pumps are ideal for bulk plant service, multiple cylinder filling applications, vaporizers, bobtails and transports.

Single- or double-ended drive shaft models are offered in 2-, 3- and 4-inch port sizes with capacities ranging from 30 to 350 U.S. gpm (114–1,325 lpm). The LGLD2 and LGLD3 models have long been popular for bobtail service because of their double-ended drive shaft arrangement, which allows the pump to be easily positioned for clockwise or counter-clockwise shaft rotation.

All models have an internal relief valve, and a replaceable casing liner and end discs for easy rebuilding of the pumping chamber if ever necessary. In addition, these pumps feature cavitation suppression liners to reduce noise, vibration and wear.

Standard construction materials include Buna-N mechanical seals and Duravanes for handling both LP-gas and anhydrous ammonia.

Maximum differential pressure for the 2- and 3-inch models is 150 psi (10.34 Bar), and 125 psi (8.62 Bar) for the 4-inch models. Ports are offered with NPT tapped companion flanges or weld flanges.

Assembled Pump Units

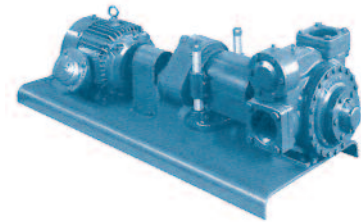
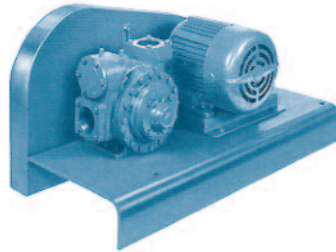

VB Drive Style

V-Belt Drive

Standard base-mounted VB units are available, complete with pump, hubs, sheaves, high-torque V-belts and belt guard, mounted on a common base, ready to accept a standard NEMA motor. All VB units are available with or without motors.

HR Drive Style

Helical Gear Reduction Drive

Standard base-mounted HR units are available, complete with pump, Blackmer Helical Gear Reducer, mounting brackets, couplings and coupling guards, mounted on a common base, ready to accept a standard NEMA motor. All HR units are available with or without motors.

Performance Curves

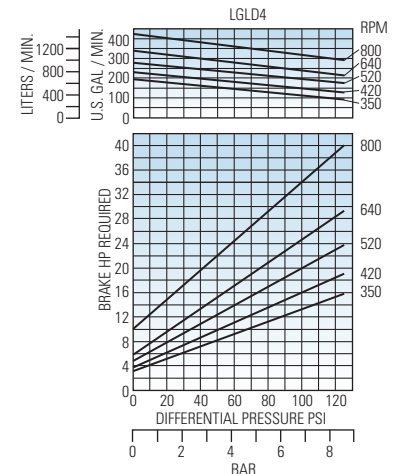
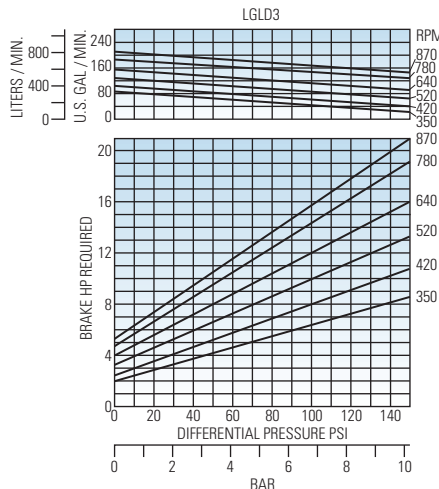
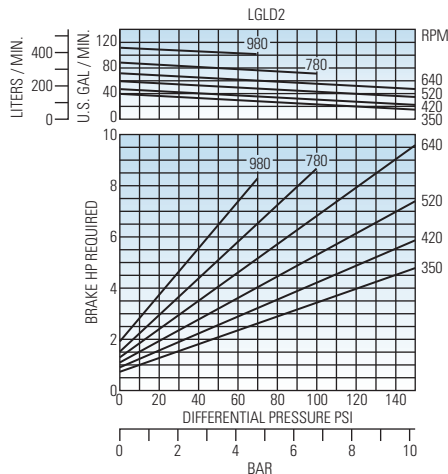

These curves are based on approximate delivery rates when handling propane or anhydrous ammonia at 80°F (26.7°C). Line restrictions such as excess flow valves, elbows, etc. will adversely affect deliveries. For propane at 32°F (0°C), actual delivery will be further reduced to about 80% of nominal. Delivery of butane at 80°F (26.7°C) will be 60% to 70% of these values, and may run as low as 35% to 45% at 32°F (0°C). This loss of delivery is not a pump characteristic but is caused by natural thermodynamic phenomena of liquefied gases.

Selection Data

When selecting a pump for truck or transport systems, use the performance curves on the opposite page. For a standard pump or assembled unit, use the table shown. The table shows brake horsepower limitations for the unit's drive and base. Check these limits against the pump brake horsepower requirements, as shown in the curves. For continuous duty applications, it is generally advisable to use pump speeds of 400 rpm or less. Peak shaving plant systems, for example, involve continuous pump duty. Moreover, pumps used in peak shaving plant systems should be sized for a capacity of at least 150% of the normal peak load to prevent system failure due to abnormal vaporization in the intake line.

Companion Flanges

Pump Model	Standard or Optional	Intake	Discharge
LGLD2	Standard	2" NPT	2" NPT
	Optional	2" Weld	2" Weld
LGLD3	Standard	3" NPT	3" NPT
	Optional	3" Weld	3" Weld
LGLD4	Standard	4" Weld	3" Weld
	Optional	4" Weld	4" Weld
	Optional	4" 300# ANSI	4" 300# ANSI

Assembled Pump Units		Pump Speed RPM (Using 1,750 RPM Motor)	Approximate Delivery of Propane at Differential Pressures and Pump Speeds Shown ¹				Maximum Differential Pressure		Maximum Working Pressure ²		Drive Rating (Maximum Horsepower Drive Will Transmit) ³			Motor Size For Mounting on Standard Base ⁴	
Model	Factory Relief Valve Setting		50 PSI (3.45 Bar)		100 PSI (6.89 Bar)		PSI	Bar	PSI	Bar	0-3 Hour Duty	3-4 Hour Duty	8-24 Hour Duty	Minimum Frame Size	Maximum Frame Size
			GPM	LPM	GPM	LPM									
LGLD2-VB	150 PSI (10.34 Bar)	660	67	254	57	216	150	10.34	350	24.13	9.2	9.2	7.8	184T	213T
		520	50	189	41	155	150	10.34	350	24.13	6.4	6.4	5.4	182T	184T
		420	40	151	30	114	150	10.34	350	24.13	4.8	4.8	4.0	182T	184T
		330	30	114	23	87	150	10.34	350	24.13	3.1	3.1	2.6	182T	182T
LGLD2-HRA	150 PSI (10.34 Bar)	640	65	246	55	208	150	10.34	350	24.13	8.9	7.1	5.7	182T	215T
		520	50	189	41	155	150	10.34	350	24.13	7.0	5.6	4.5	182T	215T
		420	40	151	30	114	150	10.34	350	24.13	5.4	4.3	3.4	182T	215T
		350	32	121	24	91	150	10.34	350	24.13	4.1	3.3	2.6	182T	215T
LGLD3-VB	150 PSI (10.34 Bar)	640	133	503	112	424	150	10.34	350	24.13	12.1	12.1	10.2	215T	254T
		520	108	409	84	318	150	10.34	350	24.13	8.9	8.9	7.5	213T	215T
		420	80	303	60	227	150	10.34	350	24.13	7.3	7.3	6.1	213T	215T
		340	59	223	42	159	150	10.34	350	24.13	5.4	5.4	4.5	184T	184T
LGLD3-HRA	150 PSI (10.34 Bar)	640	133	503	112	424	150	10.34	350	24.13	25.0	25.0	20.0	182T	256T
		520	108	409	84	318	150	10.34	350	24.13	24.3	19.4	15.5	182T	256T
		420	80	303	60	227	150	10.34	350	24.13	17.8	14.3	11.4	182T	256T
		350	63	238	45	170	150	10.34	350	24.13	14.4	11.5	9.2	182T	256T
LGLD4-VB	150 PSI (10.34 Bar)	640	270	1,022	220	833	125	8.62	350	24.13	26.9	26.9	22.8	254T	284T
		520	220	833	180	681	125	8.62	350	24.13	19.6	19.6	16.6	254T	256T
		420	170	644	130	492	125	8.62	350	24.13	15.8	15.8	13.4	215T	256T
		340	130	492	90	341	125	8.62	350	24.13	11.4	11.4	9.8	213T	215T
LGLD4-HRB	150 PSI (10.34 Bar)	640	270	1,022	220	833	125	8.62	350	24.13	30.0	30.0	26.9	182T	286T
		500	210	795	170	644	125	8.62	350	24.13	30.0	30.0	24.0	182T	286T
		400	160	606	120	454	125	8.62	350	24.13	30.0	24.1	19.3	182T	286T

¹ Check the pump's delivery and brake horsepower requirements in the performance curves on opposite page. See footnote with the curves which explains the factors that can cause delivery to vary.

² Maximum rated working pressure is 350 psi (24.13 Bar) for LPG and NH₃ (limited by U.L. and N.F.P.A. 58).

³ Maximum horsepower that standard drive (V-belt/gearbox and base) will transmit.

⁴ Motors may be specified from Electric Motor Price List No. 10-MTRG-01

Note: Refer to back cover for external bypass valve information.



LGL158 and LGLH2 High Differential Pressure Pumps



LGL 158A

Designed for the toughest LPG applications:

- Single and dual hose auto fuel dispensers
- Aerosol filling
- Vaporizer feed
- Underground tank applications
- Aboveground tank applications
- Other high differential pressure liquefied gas applications

See Spec Sheet 501-004 for more information.

LGL158 Performance

Performance at 150 psid (10.3 bar) differential pressure			Maximum Differential Pressure	Relief Valve Setting	Maximum Working Pressure
1750 rpm	1450 rpm	1150 rpm			
32.3 gpm / 5.2 hp	24 gpm / 4.3 hp	17.8 gpm / 3.4 hp	200 psi	220 psi	425 psi
122 lpm / 4 kw	91 lpm / 3.2 kw	67 lpm / 2.5 kw	13.8 Bar	15.2 Bar	29.3 Bar

U.L. listed for use on propane, butane and butane/propane mixes.

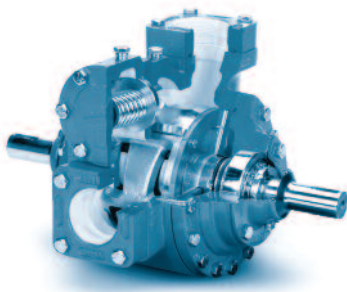

LGLH2

Make the best 2-inch LPG pump on the market even tougher – that is the LGLH2! Rated at 165 psi (11.4 Bar) differential pressure, the LGLH2 is perfect for use on bobtails filling LPG tanks on the top of multi-story buildings, high capacity LPG fueling or other high differential pressure applications.

See Spec Sheet 501-005 for more information.

LGLH2 Performance

Performance at 145 psid (10 bar) differential pressure			Maximum Differential Pressure	Relief Valve Setting	Maximum Working Pressure
780 rpm	640 rpm	520 rpm			
61 gpm / 11.7 hp	47 gpm / 9.2 hp	32.6 gpm / 7.1 hp	165 psi	190 psi	390 psi
231 lpm / 8.7 kw	178 lpm / 6.9 kw	123 lpm / 5.3 kw	11.4 Bar	13.1 Bar	26.9 Bar

U.L. listed for use on propane, butane and butane/propane mixes.



TLGLF3 & TLGLF4 Pumps Flange Mounted Pumps for Bobtails and Transports

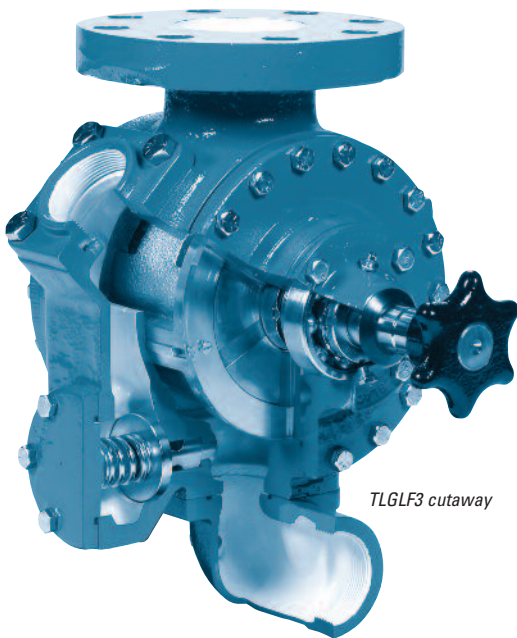

TLGLF3 cutaway

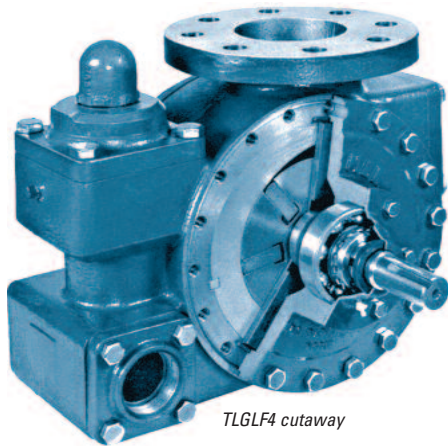

TLGLF4 cutaway

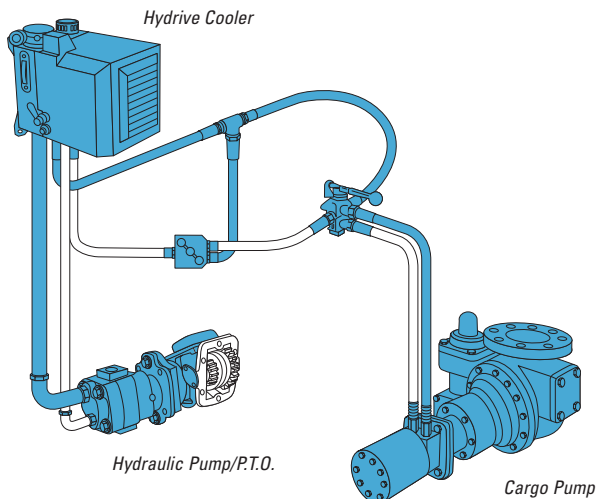

Hydrive Cooler

Hydraulic Pump/P.T.O.

Cargo Pump

Blackmer TLGLF3 and TLGLF4 pumps are designed to flange mount directly to a commercial internal control valve, in combination with the tank of a bobtail or transport. Direct mounting eliminates the need for inlet pipes, shut-off valve and external strainer which can restrict flow and cause vaporization problems. The result is smoother operation and longer pump life.

Both models are equipped with a double-ended drive shaft for clockwise or counterclockwise rotation by simply changing position of the pump. Each model also has an auxiliary intake port which can be used for emergency unloading of another tank or transport. In addition, these pumps have an internal relief valve, patented cavitation suppression liners to reduce noise, vibration and wear.

Standard construction materials for both models include Buna-N mechanical seals and Duravanes for handling both LP-gas and anhydrous ammonia. The casing liner and end discs are replaceable for easy rebuilding of the pumping chamber if ever necessary.

The TLGLF3 is widely used on bobtails because of its compact mounting arrangement, with a 3-inch ANSI intake flange and 2-inch auxiliary intake and discharge ports. Capacities range from 60 to 129 U.S. gpm (227 to 488 lpm).

The TLGLF4 offers maximum output rates, and fast turnaround time for transports. It is designed with 4-inch ANSI intake flange, a 3-inch auxiliary intake port, and twin 2-inch discharge ports which permit the use of two hoses, if necessary, to reduce pressure loss when unloading into restrictive receiving systems. Capacities range from 200 to 350 U.S. gpm (757–1,325 lpm).

Maximum differential pressure for both models is 125 psi (8.62 Bar).

Hydraulic Drive Packages

Blackmer 2-inch through 4-inch pump models are offered with complete factory engineered hydraulic drive packages. Blackmer highly recommends the use of hydraulic drive systems to maximize pump performance and extend equipment life, especially on truck mounted bobtail and transport pumps.

The Blackmer Hydrive cooler forms the heart of a hydraulic drive system, and offers up to 26 horsepower (19.4 kW) of actual heat dissipation. The Hydrive has a compact design with stainless steel. It protects the system during cold start-up, allows for remote system on/off control, and provides both system cooling and monitoring of oil filtration.

A typical hydraulic drive package includes a P.T.O., hydraulic pump, Hydrive cooler, cargo pump control valve, speed control valve, hydraulic motor, and mounting hardware. Hydraulic motor adaptor kits are also available to retrofit existing Blackmer LP gas pumps for hydraulic drive operation.

Selection Data

Pump delivery and brake horsepower requirements are listed in the table below for various differential pressures. The same data for all pressures is provided in the performance curves below.

Standard Pump		Pump Speed RPM	Approximate Delivery of Propane at Differential Pressures and Pump Speeds Shown ¹												Maximum Differential Pressure		Maximum Working Pressure ²	
Model	Factory Relief Valve Setting		50 PSI (3.45 bar)						100 PSI (6.89 Bar)						PSI	Bar	PSI	Bar
			GPM	LPM	BHP	KW	Torque		GPM	LPM	BHP	KW	Torque					
ft-lb	Kg-m	ft-lb					Kg-m											
TLGLF3	150 PSI (10.34 Bar)	870	129	488	6.5	4.8	45.9	6.3	119	450	10.9	8.1	72.5	10	125	8.62	350	24.13
		800	118	446	5.1	3.8	44.2	6.1	107	405	8.7	6.5	69.7	9.6	125	8.62	350	24.13
		650	93	352	4.3	3.2	40.4	5.6	83	314	7.9	5.9	63.7	8.8	125	8.62	350	24.13
		600	85	322	4	3	39.3	5.4	75	284	7.1	5.3	62.2	8.6	125	8.62	350	24.13
		500	70	265	3.6	2.7	37.4	5.2	68	257	6	4.5	61.5	8.5	125	8.62	350	24.13
		400	52	197	2.8	2.1	36.2	5	40	151	4.8	3.6	60.8	8.4	125	8.62	350	24.13
TLGLF4	150 PSI (10.34 Bar)	800	350	1,325	22	16	143	20	306	1,158	34	25	223	31	125	8.62	350	24.13
		650	280	1,060	15.5	11.6	125.2	17.3	245	927	25.0	18.6	201.9	27.9	125	8.62	350	24.13
		600	260	984	14.3	10.7	125.1	17.3	220	833	23.0	17.2	201.3	27.8	125	8.62	350	24.13
		500	210	795	11.9	8.9	125.0	17.3	170	644	19.0	14.2	199.5	27.6	125	8.62	350	24.13
		400	160	606	9.5	7.1	124.7	17.2	120	454	15.2	11.3	199.5	27.6	125	8.62	350	24.13

¹ Check the pump's delivery and brake horsepower requirements in the performance curves below. See footnote with the curves which explains the factors that can cause delivery to vary.

² Maximum rated working pressure is 350 psi (24.13 Bar) for LPG and NH₃ (limited by U.L. and N.F.P.A. 58).

Note: Refer to back cover for external bypass valve information.

Performance Curves

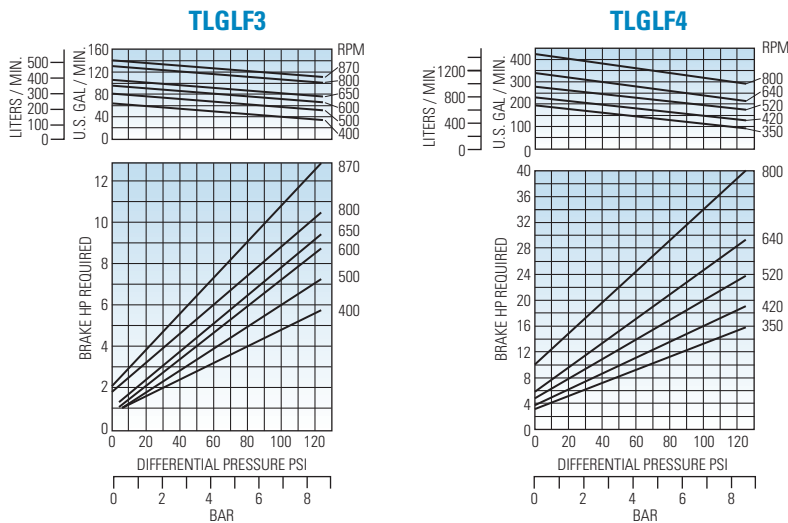

NOTE: Blackmer Characteristic Curves are based on Brake Horsepower (BHP). To determine Motor Horsepower, drive train inefficiencies must be added to the BHP. These curves are based on approximate delivery rates when handling propane or anhydrous ammonia at 80°F (26.7°C). Line restrictions such as excess flow valves, elbows, etc., will adversely effect deliveries. For propane at 32°F (0°C), actual delivery will be further reduced to about 80% of nominal. Delivery of butane at 80°F (26.7°C) will be 60 to 70% of these values, and may run as low as 35 to 45% at 32°F (0°C). This loss of delivery is not a pump characteristic but is caused by natural thermodynamic phenomena of liquefied gases.

LPG Pump Warranty – One Year Performance Assurance

Should any Blackmer LPG pump (LGL, TLGL and LG models) or bypass valve fail in the transfer of propane, butane and propane/butane mixture within one (1) year of the original installation or eighteen (18) months after shipment from the factory, regardless of cause (except for intentional or gross misuse), free replacement components will be provided to return the pump to as new performance.

This offer is limited to one claim per installation.

PLEASE NOTE: For the One Year Performance Assurance to be valid, a Blackmer Pump Warranty Registration must be supplied to Blackmer via web registration or postcard.

For additional information, see Blackmer LPG Pump Warranty page #001-004.

Available Companion Flanges and Flanged Elbows

Pump	Discharge	Auxiliary Intake	Intake
TLGLF3	2" NPT Flanged Elbow	2" NPT Flanged	3" 300 lb. ANSI Mounting Flange
	2" Weld Flanged Elbow	2" NPT Flanged Elbow	
	2" NPT Flanged	2" Weld Flanged	
	2" Weld Flanged	2" Weld Flanged Elbow	
		Blanking Flange	
TLGLF4	Twin 2" NPT Flanges	3" NPT Flanged	4" 300 lb. ANSI Mounting Flange
	Twin 2" Weld Flanges	3" Weld Flanged	
		Blanking Flange	
		4" Weld Flanged	



LB161, LB361, LB601 & LB942 Compressors

Oil-Free Gas Compressors for Liquid Transfer and Vapor Recovery

Blackmer oil-free gas compressors deliver high efficiency in handling propane, butane, anhydrous ammonia and other liquefied gases. They are ideal for rail car unloading and vapor recovery applications. The single-stage, reciprocating compressors are designed to give maximum performance and reliability under the most severe service conditions. All pressure parts are of ductile iron construction for greater resistance to both thermal and mechanical shock. They are designed for ease of maintenance, with all components readily accessible.

Models are available with capacities from 7 to 125 cfm (11.9 to 212 m³/h) with working pressure up to 425 psia (29.31 Bar).

Gas compressors for liquid transfer

Many liquid transfer applications can be handled more efficiently with a gas compressor than a liquid pump. They include unloading of transports and pressure vessels where system piping restricts flow and may cause a pump to cavitate; unloading of LP gas from rail cars, and other installations that require an initial lift to the liquid.

How liquid transfer is accomplished

When transferring liquid, a compressor creates a slight pressure differential between the vessel being unloaded and the receiving tank. The suction stroke of the compressor piston draws in vapor and decreases the receiving tank pressure. The discharge stroke moves a measured volume of vapor at a higher pressure into the supply tank where it displaces an equal volume of liquid through a separate line into the receiving tank. Generally, the liquid flow rate will be 5 to 6 U.S. gpm for each cubic foot (ft³) of piston displacement (670 - 775 liters per cubic meter [m³]).

Gas compressors for vapor recovery

When the liquid transfer phase has been completed, a significant amount of product (vapor and liquid) is left in the tank car (often 3% or more of the tank's capacity). Recovery of product with a compressor is a simple operation, and thus a compressor can quickly pay for itself.

How vapor recovery is accomplished

Vapor recovery is accomplished with the use of a four-way valve. By rotating the valve handle 90°, gas flow is reversed and the vapor pressure within the supply vessel is reduced. At this point, remaining liquid vaporizes and is quickly recovered. As the tank pressure is drawn down further, remaining vapors are also recovered to an economical level. Recovered vapor is discharged into the liquid area of the receiving tank and then condensed back into a liquid state.

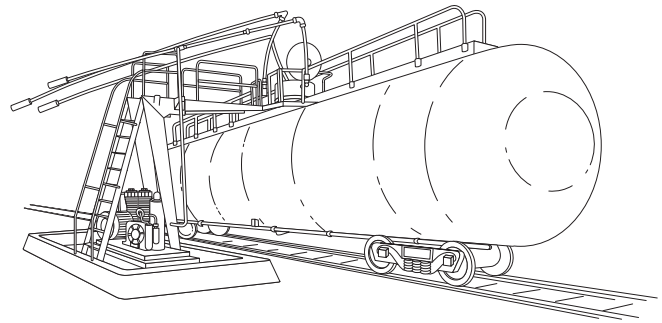

Tank car vapor recovery system

Propane Vapor Recovery

The chart and graph illustrate typical volumes of liquid that may be recovered at various pressures and operating times, based on a 33,000 U.S. water gallon capacity (124,915 liters) tank car – using a Blackmer LB361 gas compressor with 36 CFM (60.3 m³/h piston displacement).

For example, when the liquid transfer phase of unloading is completed, the vapor pressure reads 150 psig (10.34 Bar gauge). At this condition, there would be approximately 1,315 U.S. gallons (4,978 liters) of LP gas in vapor form remaining in the tank car.

Of this amount, 845 U.S. gallons (3,199 liters) can be economically recovered in less than three hours.

Beginning Tank Pressure		Total Product ¹ (In Vapor Form)		Economically Recoverable Product ²	
PSIG	Bar	U.S. Gals.	Liters	U.S. Gals.	Liters
200	13.79	1,650	6,246	1,153	4,365
175	12.07	1,485	5,621	969	3,668
150	10.34	1,315	4,978	845	3,199
125	8.62	1,137	4,304	713	2,699
100	6.89	953	3,607	580	2,196
75	5.17	760	2,877	441	1,669
50	3.45	561	2,124	419	1,586

¹ Physical properties are based on N.F.P.A. 58 data for commercial propane. Vapor pressure 205 psig (14.13 Bar) @ 100°F (37.8°C).
² Economically recoverable product is based on reduction of tank pressure to 25% of original value. Residual liquid not included.
 Note: A different size tank will have a proportional relationship to the values shown above. For example, a 10,000 U.S. gallon (27,850 liters) tank would represent 30.3% of the values given.

Volume Recovered From 33,000 U.S. Gallon Tank (124,915 Liters)

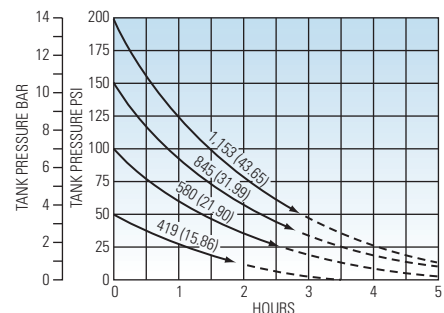

Overall efficiency of plant piping may improve or detrimentally affect compressor performance.

All figures are approximate and rounded off for easy reading.

Additional information for liquefied gases other than propane is available: consult your Blackmer representative.

Design Features



High efficiency valves move more gas volume

The heart of any compressor is its valve assembly and Blackmer valves are specifically designed for non-lubricated gas applications. With precisely engineered clearances, spring tension, and a special finish, these valves seat more positively so more gas is moved with each piston stroke. Blackmer valves offer greater strength, quiet operation, and long life.

O-Ring seals - head and cylinder

The head and cylinder are sealed with O-rings to ensure positive sealing under all operating conditions.



Pressure assisted piston rings for positive seating

Constructed of self-lubricating PTFE, Blackmer's special ring design provides maximum sealing efficiency with minimal friction wear. The result: peak performance and extended compressor service life.

Heavy-duty crankshaft

The ductile iron crankshaft is precision ground with integral counterweights for smooth, quiet operation. Rifle drilling ensures positive oil distribution to the wrist pin and connecting rod bearings.

Pressure lubricated bearings

A rotary oil pump provides positive oil distribution to all running gear components for long life and minimal wear.

Ductile iron pistons

Heavy-duty ductile iron pistons are connected with a single positive locking nut which eliminates potential problems associated with more complex designs.



Self-adjusting piston rod seals

Crankcase oil contamination and cylinder blow-by is prevented with loaded glass-filled PTFE seals which maintain a constant sealing pressure around the piston rods.

Ductile iron construction

All pressure parts are of ductile iron for greater resistance to both thermal and mechanical shock.

Wear-resistant crosshead assemblies

Designed for maximum lubrication and wear resistance.

Multiple seal options

For applications that require maximum leakage control, double piston rod seals and a distance piece chamber are available for all Blackmer LB compressors.

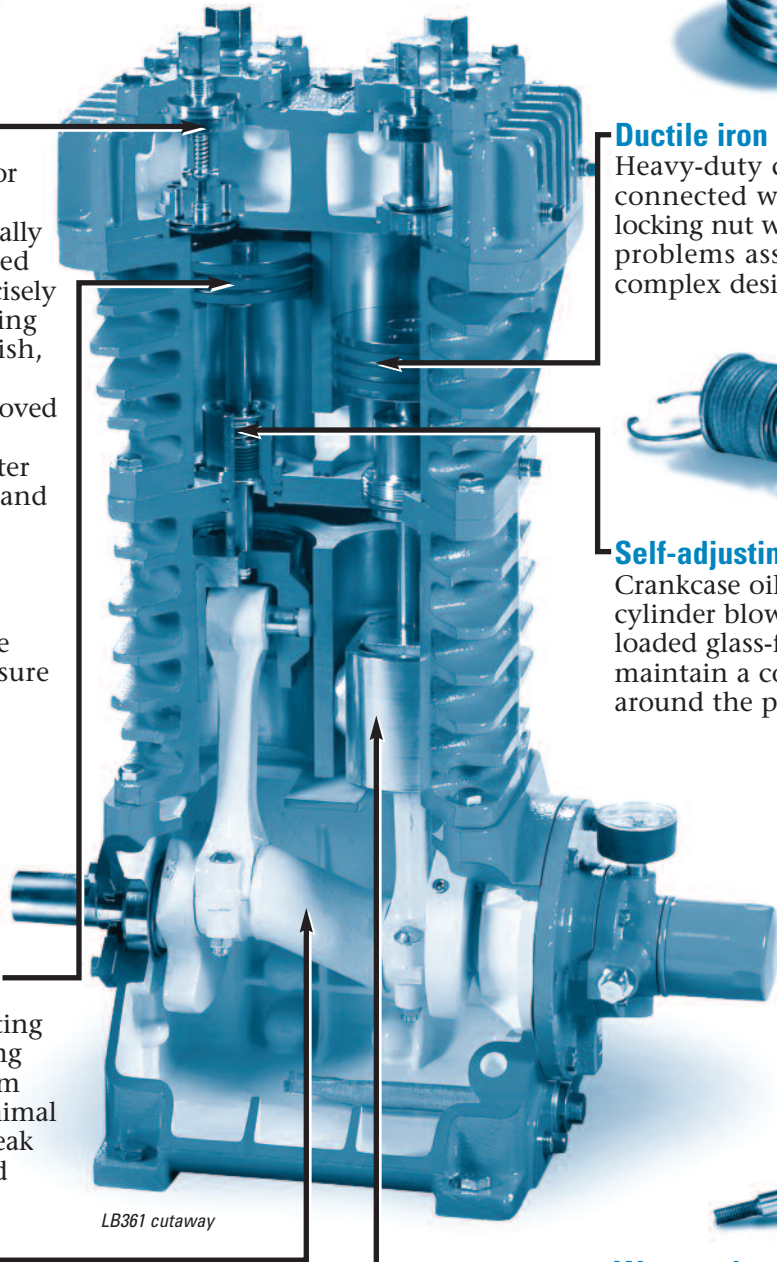



Compressor Selection Data

To select a compressor that best fits your application requirements, use the charts shown. The data provided is based on approximate delivery rates when handling propane or anhydrous ammonia. Actual capacities will depend upon line restrictions, size and length of piping. Horsepower requirements for both liquid transfer and vapor recovery applications are based on moderate climatic conditions.



LB601

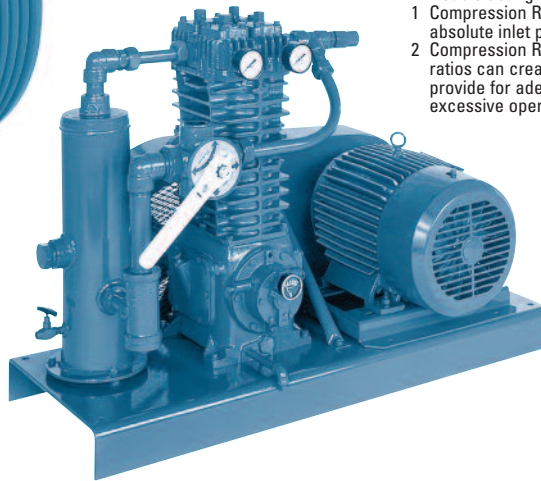

LB361LU

Engineering Specifications

	Compressor Model			
	LB161 LB162	LB361 LB362	LB601 LB602	LB942
Bore - Inches (mm)	3.0 (76.2)	4.0 (101.6)	4.625 (117.4)	4.625* (117.4)
Stroke - Inches (mm)	2.5 (63.5)	3.0 (76.2)	4.0 (101.6)	4.0 (101.6)
Piston Displacement CFM (m³/h) @ 100 rpm	2.0 (3.4)	4.3 (7.3)	7.7 (13.1)	14.9 (25.38)
@ 825 rpm	16.5 (28.0)	35.5 (60.3)	63.5 (107.9)	123 (209)
Compressor Speed				
Minimum rpm	350	350	350	350
Maximum rpm	825	825	825	825
Maximum Working Pressure - psia (Bar)	350 (24.13)	350 (24.13)	350 (24.13)	350 (24.13)
Maximum Brake Horsepower (kw)	7.5 (6)	15 (11)	30 (22)	50 (37)
Max. Discharge Temperature °F (°C)	350 (177)	350 (177)	350 (177)	350 (177)
Max. Compression Ratio¹				
Continuous Duty ²	5	5	5	5
Intermittent Duty ²	9	9	9	9

* Double acting

1 Compression Ratio defined as absolute discharge pressure divided by absolute inlet pressure.

2 Compression Ratios are limited by discharge temperature. High compression ratios can create excessive heat, i.e., over 350°F (177°C). The duty cycle must provide for adequate cooling time between periods of operation to prevent excessive operating temperature.

Compressor Selection Data: Propane and Anhydrous Ammonia

Model	Speed RPM	Approximate Liquid Transfer Delivery ¹		Piston Displacement		Driver Size ²		Pipe Diameter ³			
		U.S. GPM	LPM	CFM	M ³ /H	HP	KW	Vapor		Liquid	
								in.	mm	in.	mm
LB161 LB162	425	49	186	8.5	14.4	3	2	1	25	2	50
	560	65	246	11.2	19.0	5	4				
	715	83	314	14.3	24.3	5	4				
	780	90	341	15.6	26.5	7.5	6				
	810	92	348	16.2	27.5	7.5	6				
LB361 LB362	495	123	466	21.3	36.2	7.5	6	1 1/4	32	2 1/2	65
	540	134	507	23.2	39.5	10	7				
	650	161	609	28.0	47.5	10	7				
	780	194	734	33.5	57.0	15	11				
	810	201	761	34.8	59.1	15	11				
LB601 LB602	550	245	927	42.4	72.0	15	11	2 - 2 1/2	50-65	4	100
	640	285	1,079	49.3	83.7	20	15				
	700	311	1,177	53.9	91.6	20	15				
	790	351	1,329	60.8	103.4	25	19				
LB942	470	400	1,514	70	119	25	19	3 - 4	76-102	6	152
	565	480	1,817	84	143	30	22				
	750	640	2,422	112	190	40	30				
	800	680	2,575	119	202	50	37				

1 Delivery will depend on proper system design, pipe sizing and valve capacity.

2 Horsepower is for liquid transfer and vapor recovery in moderate climates. For liquid transfer without vapor recovery, horsepower will be lower. For severe climates, contact your Blackmer representative for horsepower required.

3 Use next larger pipe size if piping exceeds 100 feet (30 meters).

4 LBLTRAN (a computer program available at Blackmer's website www.blackmer.com) may be used to perform a detailed performance report based on your system parameters.

Standard Compressor Packages

Blackmer offers a variety of factory assembled compressor packages to fit most application requirements. Standard base mounted units are available in the following styles:

CO - COMPRESSOR ONLY Includes basic compressor with flywheel.

B - BASE MOUNTED UNIT Includes compressor, pressure gauges, formed steel base, V-belt drive with belt guard, and adjustable motor base, less motor.

E - EXTENDED SHAFT Includes compressor with flywheel and extended crankshaft.

TU - TRANSFER UNIT Includes compressor, pressure gauges, formed steel base, liquid trap assembly with a mechanical float, V-belt drive with belt guard, and adjustable motor base, less motor.

TC or TW - TRANSFER UNIT Includes compressor, pressure gauges, steel base, ASME code stamped liquid trap assembly (complete with relief valve and a NEMA 7 electric float switch for Propane service), V-belt drive with belt guard, and adjustable motor slide base. TW units feature welded and flanged piping.

LU - LIQUID TRANSFER/VAPOR RECOVERY UNIT Includes compressor, pressure gauges, formed steel base, liquid trap assembly with a mechanical float, inlet strainer, interconnecting piping, 4-way valve, V-belt drive with belt guard, and adjustable motor base, less motor.

LC or LW - LIQUID TRANSFER/VAPOR RECOVERY UNIT Includes compressor, pressure gauges, steel base, ASME code stamped liquid trap assembly (complete with relief valve and a NEMA 7 electric float switch for Propane service), inlet strainer, interconnecting piping, 4-way valve, V-belt drive with belt guard, and adjustable motor base, less motor. LW units feature welded and flanged piping.

All Compressor models are available with or without motors or accessories. Special engine drives, control panels and custom emergency evacuation units can be furnished on a special order basis.

Blackmer compressors can also be mounted on transports with direct drive or V-belt drive, as shown below.

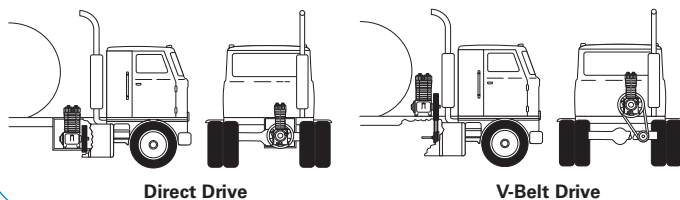

HD Series Compressors

Blackmer also offers a line of single and two-stage industrial gas compressors with double or triple piston rod seals and air or water cooling. Consult your Blackmer representative for more information and specifications.

Optional Accessories

Motors: Standard voltage and sizes in stock.

Motor slide rails: Offer easy adjustment for standard motor frame sizes.

Engines: Diesel, propane or gasoline fueled engines available.

Liquid traps: Standard liquid traps have a mechanical float to protect the compressor by preventing liquid from entering. These traps may be fitted with an electric float switch to sound an alarm or stop the compressor in the event of high liquid level. Larger traps with ASME code construction and one or two electric float switches are also available.



Vapor strainer assembly: Features a 30-mesh replaceable stainless steel screen and ductile iron body.



Four-way valve: Four-way valves allow easy switching from liquid transfer to vapor recovery operation by reversing the system flow direction. Standard valves are ductile iron with a handle and easy-to-read flow direction indicator. Valves with electric or pneumatic actuation are available if remote operation is desired.



Pressure gauges: Standard 1/4-inch NPT liquid-filled for head mounting.

Extended crankshaft: For direct drive mounting, or V-belt drive applications.

Base plates: Formed steel or fabricated skid type.

Belt guards: Heavy-duty 14-gauge steel, stainless steel or non-sparking aluminum construction.

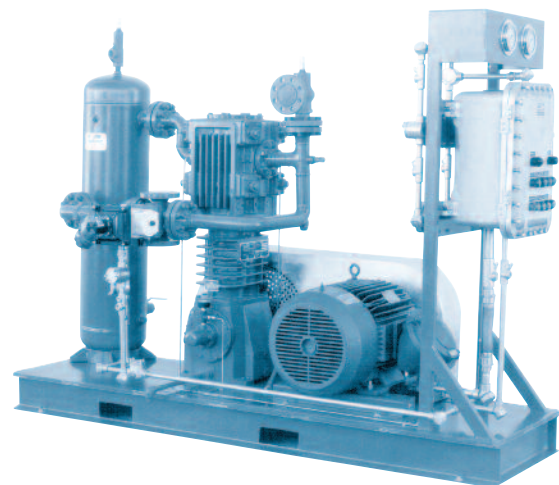

*Custom-engineered
LPG transfer compressor
package*



Bypass Valves Precise, On-Line Pressure Protection



BV $\frac{3}{4}$ "/BV1

BV2

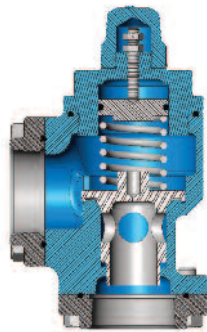

BV2 cutaway

Selection Guide

Model BV $\frac{3}{4}$ (ports are $\frac{3}{4}$ -inch NPT tapped)
Model BV1 (ports are 1-inch NPT tapped)

These models are commonly used for cylinder-filling system. Either valve can be used with 1- $\frac{1}{4}$ or 1- $\frac{1}{2}$ -inch Blackmer pump models.

Model BV1 $\frac{1}{2}$ (ports are 1- $\frac{1}{2}$ -inch NPT tapped)
Model BV1 $\frac{1}{2}$ (ports are 1- $\frac{1}{2}$ -inch NPT tapped)

These models are normally used for bobtail trucks and smaller bulk plant systems. Either valve can be used with 2 or 3-inch Blackmer pump models. Both valves are available with optional springs for use with the LGL 158 or LGLH2.

Model BV2 (ports have 2-inch NPT companion flanges, 1- $\frac{1}{2}$ -inch and 1- $\frac{1}{2}$ -inch NPT and WELD bolt-on flanges are available)

The BV2 model is widely used for transports or larger bulk plant systems. It is recommended for use with 3 and 4-inch Blackmer pump models. The BV2 is factory set at 125 PSI.

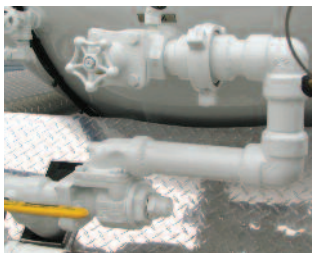

Blackmer differential bypass valves are designed to protect pumps and system components from excessive pressure damage, and no LP gas pump installation is complete without one. Blackmer offers five different models

that provide full-flow pressure control to 250 U.S. gpm (946 lpm) at 120 psid (8.27 Bar). Installation is easy with NPT tapped ports in sizes from $\frac{3}{4}$ " to 2". All models are suitable for both LP gas and anhydrous ammonia service.

Technical Assistance

In some applications, selecting the right pump or compressor may require more detailed information than can be presented in this bulletin. Your Blackmer representative can help you find the correct equipment to ensure the best performance possible for your specific application.

If you have a unique gas or fluid handling problem, please contact Blackmer at the telephone or fax number listed below.

Distributed by:

Maximum flow-through valve

Model	Maximum Rated Flow* - GPM (LPM) @			
	20 PSI (1.38 Bar)	50 PSI (3.45 Bar)	80 PSI (5.52 Bar)	120 PSI (8.27 Bar)
BV1	25 (95)	40 (151)	50 (189)	60 (227)
BV1 $\frac{1}{2}$	60 (227)	80 (303)	100 (379)	125 (473)
BV2	150 (568)	180 (681)	220 (833)	250 (946)

*Normal maximum bypass flow rates without significantly exceeding the set pressure limit.

In operation, Blackmer valves provide exceptionally close pressure control, even under widely varying bypass flow conditions. The performance curve in Figure 4 below shows how a Blackmer valve maintains a virtually constant pressure of 100 psi (6.89 Bar) even as the volume being bypassed rises from 10 gpm to 100 gpm (38-378 lpm). Although the curve is that of a BV1 $\frac{1}{2}$ " valve, the precision it demonstrates is typical of any Blackmer valve.

Blackmer bypass valves have no small, easily plugged, sensing passages; and with only two moving parts, their operation is simple and reliable. They open precisely at the preset spring pressure, and they close smoothly and quietly, thanks to a patented dash-pot design. As shown in Figure 5, a small chamber in the valve stem fills with liquid when the valve opens. This liquid then provides a hydraulic cushion preventing the valve from slamming shut if pressure is suddenly released. It also minimizes chatter and valve seat wear when pressures hover around the crucial limit.

FIGURE 4. Bypass volume/pressure curve BV1 $\frac{1}{2}$ "

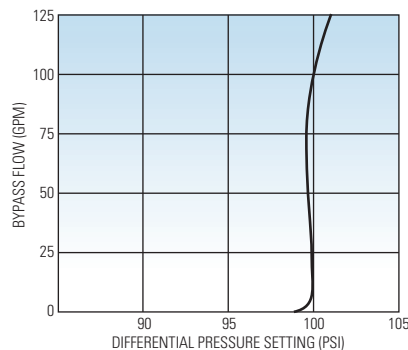
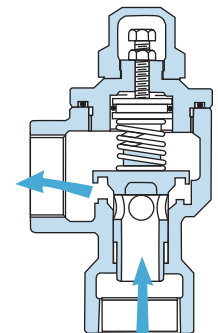

FIGURE 5. Bypass valve operation



Dash-pot chamber cushions closing of valve



World Headquarters

1809 Century Avenue SW
Grand Rapids, MI 49503-1530 USA
T 616.241.1611 F 616.241.3752



www.blackmer.com